

***TPS54673EVM-225 6-Amp***  
***TPS54873EVM-225 8-Amp***  
***SWIFT™ Regulator With Disabled Sink During  
Start-Up Evaluation Module***

*User's Guide*

## IMPORTANT NOTICE

Texas Instruments Incorporated and its subsidiaries (TI) reserve the right to make corrections, modifications, enhancements, improvements, and other changes to its products and services at any time and to discontinue any product or service without notice. Customers should obtain the latest relevant information before placing orders and should verify that such information is current and complete. All products are sold subject to TI's terms and conditions of sale supplied at the time of order acknowledgment.

TI warrants performance of its hardware products to the specifications applicable at the time of sale in accordance with TI's standard warranty. Testing and other quality control techniques are used to the extent TI deems necessary to support this warranty. Except where mandated by government requirements, testing of all parameters of each product is not necessarily performed.

TI assumes no liability for applications assistance or customer product design. Customers are responsible for their products and applications using TI components. To minimize the risks associated with customer products and applications, customers should provide adequate design and operating safeguards.

TI does not warrant or represent that any license, either express or implied, is granted under any TI patent right, copyright, mask work right, or other TI intellectual property right relating to any combination, machine, or process in which TI products or services are used. Information published by TI regarding third-party products or services does not constitute a license from TI to use such products or services or a warranty or endorsement thereof. Use of such information may require a license from a third party under the patents or other intellectual property of the third party, or a license from TI under the patents or other intellectual property of TI.

Reproduction of information in TI data books or data sheets is permissible only if reproduction is without alteration and is accompanied by all associated warranties, conditions, limitations, and notices. Reproduction of this information with alteration is an unfair and deceptive business practice. TI is not responsible or liable for such altered documentation.

Resale of TI products or services with statements different from or beyond the parameters stated by TI for that product or service voids all express and any implied warranties for the associated TI product or service and is an unfair and deceptive business practice. TI is not responsible or liable for any such statements.

### Mailing Address:

Texas Instruments  
Post Office Box 655303  
Dallas, Texas 75265

## EVM IMPORTANT NOTICE

Texas Instruments (TI) provides the enclosed product(s) under the following conditions:

This evaluation kit being sold by TI is intended for use for **ENGINEERING DEVELOPMENT OR EVALUATION PURPOSES ONLY** and is not considered by TI to be fit for commercial use. As such, the goods being provided may not be complete in terms of required design-, marketing-, and/or manufacturing-related protective considerations, including product safety measures typically found in the end product incorporating the goods. As a prototype, this product does not fall within the scope of the European Union directive on electromagnetic compatibility and therefore may not meet the technical requirements of the directive.

Should this evaluation kit not meet the specifications indicated in the EVM User's Guide, the kit may be returned within 30 days from the date of delivery for a full refund. **THE FOREGOING WARRANTY IS THE EXCLUSIVE WARRANTY MADE BY SELLER TO BUYER AND IS IN LIEU OF ALL OTHER WARRANTIES, EXPRESSED, IMPLIED, OR STATUTORY, INCLUDING ANY WARRANTY OF MERCHANTABILITY OR FITNESS FOR ANY PARTICULAR PURPOSE.**

The user assumes all responsibility and liability for proper and safe handling of the goods. Further, the user indemnifies TI from all claims arising from the handling or use of the goods. Please be aware that the products received may not be regulatory compliant or agency certified (FCC, UL, CE, etc.). Due to the open construction of the product, it is the user's responsibility to take any and all appropriate precautions with regard to electrostatic discharge.

**EXCEPT TO THE EXTENT OF THE INDEMNITY SET FORTH ABOVE, NEITHER PARTY SHALL BE LIABLE TO THE OTHER FOR ANY INDIRECT, SPECIAL, INCIDENTAL, OR CONSEQUENTIAL DAMAGES.**

TI currently deals with a variety of customers for products, and therefore our arrangement with the user **is not exclusive**.

TI assumes **no liability for applications assistance, customer product design, software performance, or infringement of patents or services described herein**.

Please read the EVM User's Guide and, specifically, the EVM Warnings and Restrictions notice in the EVM User's Guide prior to handling the product. This notice contains important safety information about temperatures and voltages. For further safety concerns, please contact the TI application engineer.

Persons handling the product must have electronics training and observe good laboratory practice standards.

No license is granted under any patent right or other intellectual property right of TI covering or relating to any machine, process, or combination in which such TI products or services might be or are used.

Mailing Address:

Texas Instruments  
Post Office Box 655303  
Dallas, Texas 75265

## **EVM WARNINGS AND RESTRICTIONS**

It is important to operate this EVM within the specified input and output voltage ranges described in the EVM User's Guide.

Exceeding the specified input range may cause unexpected operation and/or irreversible damage to the EVM. If there are questions concerning the input range, please contact a TI field representative prior to connecting the input power.

Applying loads outside of the specified output range may result in unintended operation and/or possible permanent damage to the EVM. Please consult the EVM User's Guide prior to connecting any load to the EVM output. If there is uncertainty as to the load specification, please contact a TI field representative.

During normal operation, some circuit components may have case temperatures greater than 55°C. The EVM is designed to operate properly with certain components above 60°C as long as the input and output ranges are maintained. These components include but are not limited to linear regulators, switching transistors, pass transistors, and current sense resistors. These types of devices can be identified using the EVM schematic located in the EVM User's Guide. When placing measurement probes near these devices during operation, please be aware that these devices may be very warm to the touch.

### **Mailing Address:**

Texas Instruments  
Post Office Box 655303  
Dallas, Texas 75265

# Read This First

---

---

---

### ***About This Manual***

This user's guide describes the characteristics, operation, and use of the TPS54673EVM-225 and TPS54873EVM-225 evaluation modules. It covers all pertinent areas involved to properly use this EVM board along with the devices that it supports. The physical PCB layout, schematic diagram, and circuit descriptions are included.

### ***How to Use This Manual***

This document contains the following chapters:

- Chapter 1—Introduction
- Chapter 2—Test Setup and Results
- Chapter 3—Board Layout
- Chapter 4—Schematic and Bill of Materials

### ***Information About Cautions and Warnings***

This book may contain cautions and warnings.

**This is an example of a caution statement.**

**A caution statement describes a situation that could potentially damage your software or equipment.**

**This is an example of a warning statement.**

**A warning statement describes a situation that could potentially cause harm to you.**

The information in a caution or a warning is provided for your protection. Please read each caution and warning carefully.

### ***Related Documentation From Texas Instruments***

To obtain a copy of any of the following TI documents, call the Texas Instruments Literature Response Center at (800) 477 – 8924 or the Product Information Center (PIC) at (972) 644 – 5580. When ordering, identify this manual by its title and literature number. Updated documents can also be obtained through our website at [www.ti.com](http://www.ti.com).

**Data Sheets:**

TPS54673

TPS54873

**Literature Number:**

SLVS433

SLVS444

### ***FCC Warning***

This equipment is intended for use in a laboratory test environment only. It generates, uses, and can radiate radio frequency energy and has not been tested for compliance with the limits of computing devices pursuant to subpart J of part 15 of FCC rules, which are designed to provide reasonable protection against radio frequency interference. Operation of this equipment in other environments may cause interference with radio communications, in which case the user at his own expense will be required to take whatever measures may be required to correct this interference.

### ***Trademarks***

TI Logo is a trademark of Texas Instruments Incorporated. PowerPAD is a trademark of Texas Instruments Incorporated.

# Contents

---

---

---

<b>1</b>	<b>Introduction</b> .....	<b>1-1</b>
1.1	Background .....	1-2
1.2	Performance Specification Summary .....	1-2
1.3	Modifications .....	1-4
<b>2</b>	<b>Test Setup and Results</b> .....	<b>2-1</b>
2.1	Input/Output Connections .....	2-2
2.2	Efficiency .....	2-3
2.3	Power Dissipation .....	2-5
2.4	Output Voltage Regulation .....	2-6
2.5	Load Transients .....	2-8
2.6	Loop Characteristics .....	2-9
2.7	Output Voltage Ripple .....	2-11
2.8	Input Voltage Ripple .....	2-12
2.9	Start-Up .....	2-13
<b>3</b>	<b>Board Layout</b> .....	<b>3-1</b>
3.1	Layout .....	3-2
<b>4</b>	<b>Schematic and Bill of Materials</b> .....	<b>4-1</b>
4.1	Schematic .....	4-2
4.2	Bill of Materials .....	4-3

# Figures

---

---

---

1-1	Frequency Trimming Resistor Selection Graph	1-4
2-1	Connection Diagram	2-2
2-2	Measured Efficiency, TPS54673	2-3
2-3	Measured Efficiency, TPS54873	2-4
2-4	Measured Circuit Losses	2-5
2-5	Load Regulation	2-6
2-6	Line Regulation	2-7
2-7	Load Transient Response, TPS54673	2-8
2-8	Load Transient Response, TPS54873	2-8
2-9	Measured Loop Response, TPS54673, $V_I = 3\text{ V}$	2-9
2-10	Measured Loop Response, TPS54673, $V_I = 6\text{ V}$	2-9
2-11	Measured Loop Response, TPS54873, $V_I = 4\text{ V}$	2-10
2-12	Measured Loop Response, TPS54873, $V_I = 6\text{ V}$	2-10
2-13	Measured Output Voltage Ripple, TPS54673	2-11
2-14	Measured Output Ripple Voltage, TPS54873	2-11
2-15	Input Voltage Ripple, TPS54673	2-12
2-16	Input Voltage Ripple, TPS54873	2-12
2-17	Measured Start-Up Waveform, TPS54673 With No Precharge	2-13
2-18	Measured Start-Up Waveform, TPS54373 With Precharge	2-14
2-19	Measured Start-Up Waveform, TPS54673 With Precharge and No Load	2-14
2-20	Measured Start-Up Waveform	2-15
2-21	Measured Start-Up Waveform, TPS54873 With Precharge	2-15
2-22	Measured Start-Up Waveform, TPS54873 With Precharge and No Load	2-16
3-1	Top-Side Layout	3-2
3-2	Internal Layer 1 Layout	3-3
3-3	Internal Layer 2 Layout	3-3
3-4	Bottom Side Layout (Looking From Top Side)	3-4
3-5	Top Side Assembly	3-4
3-6	Bottom Side Assembly (Showing Optional Components)	3-5
4-1	TPS54x73EVM-225 Schematic	4-2



# Tables

---

---

---

1-1	Input Voltage and Output Current Summary .....	1-2
1-2	TPS54673EVM-225 Performance Specification Summary .....	1-3
1-3	TPS54873EVM-225 Performance Specification Summary .....	1-3
1-4	Output Voltage Programming .....	1-4
4-1	TPS54x73EVM-225 Bill of Materials .....	4-3



# Introduction

---

---

---

---

This chapter contains background information for the TPS54673 and TPS54873, as well as support documentation for the TPS54673EVM-225 and TPS54873EVM-225 evaluation modules (SLVP225).

The TPS54x73EVM-225 performance specifications, schematic, and bill of materials are given.

<b>Topic</b>	<b>Page</b>
<b>1.1 Background</b> .....	<b>1-2</b>
<b>1.2 Performance Specification Summary</b> .....	<b>1-2</b>
<b>1.3 Modifications</b> .....	<b>1-4</b>

## 1.1 Background

The TPS54x73EVM-225 evaluation module uses the TPS54673 or TPS54873 synchronous buck regulators with disabled sink during start-up (DSDS) to provide an output voltage of from 0.9 V to 2.5 V from a nominal 3.3 V input or 0.9 V to 3.3 V for a nominal 5-V input. Rated input voltage and output current range is given in *Table 1–1*. These EVMs are designed to demonstrate the small PCB areas that may be achieved when designing with the TPS54x73 family of regulators. The switchover frequency is set at a nominal 700 kHz, allowing the use of a small footprint 0.65  $\mu$ H output inductor. The MOSFETs of the TPS54x73 are incorporated inside the TPS54x73 package. This eliminates the need for external MOSFETs and their associated drivers. The low drain-to-source on resistance of the MOSFETs gives the TPS54x73 high efficiency and helps to keep the junction temperature low at high output currents. The compensation components are provided external to the IC, and they allow for an adjustable output voltage and a customizable loop response. The disabled sink during start-up (DSDS) feature allows the TPS54x73 family of regulators to be used in applications where it is necessary to prebias the output to maintain a specified difference between I/O and core voltages during start-up.

*Table 1–1. Input Voltage and Output Current Summary*

<b>EVM</b>	<b>Input Voltage Range</b>	<b>Output Current Range</b>
TPS54673EVM-225	3.0 V to 6.0 V	–6 A to 6 A
TPS54873EVM-225	4.0 V to 6.0 V	–8 A to 8 A

## 1.2 Performance Specification Summary

A summary of the TPS54x73EVM–225 performance specifications is provided in *Table 1–2* and *Table 1–3*. All specifications are given for an an output voltage of 3.3 V and an output voltage of 2.5 V for the TPS54673 and an uput voltage of 5 V and an output voltage of 3.3 V for the TPS54873. The ambient temperature is 25°C, for all measurements, unless otherwise noted. The data presented in *Table 1–2* and *Table 1–3* are compiled with no precharge on the output (J3 open, no voltage source present on J4). Using the precharge circuitry on this EVM requires careful consideration of line and load conditions for proper operation and may limit the useful operating range of the TPS54x73 device.

Table 1–2. TPS54673EVM-225 Performance Specification Summary

Specification	Test Conditions	Min	Typ	Max	Units
Input voltage range		3.0	3.3 or 5.0	6.0	V
Output voltage set point		0.9	2.5	3.3	V
Output current range	$V_I = 3\text{ V to }6\text{ V}$			6	A
Line regulation (see Note 1)	$I_O = 3\text{ A}, V_I = 3.02\text{ V to }6\text{ V}$		$\pm 4$		mV
Load regulation	$V_I = 3.3\text{ V}, I_O = 0\text{ A to }6\text{ A}$		$\pm 4$		mV
Load transient response	$I_O = 1.5\text{ A to }4.5\text{ A}, t_r = 40\ \mu\text{s}$		-20		mV <sub>PK</sub>
			120		$\mu\text{s}$
	$I_O = 4.5\text{ A to }1.5\text{ A}, t_f = 40\ \mu\text{s}$		20		mV <sub>PK</sub>
			100		$\mu\text{s}$
Loop bandwidth	$V_I = 3\text{ V}$		80		kHz
Phase margin	$V_I = 3\text{ V}$		48		°
Loop bandwidth	$V_I = 6\text{ V}$		125		kHz
Phase margin	$V_I = 6\text{ V}$		49		°
Input ripple voltage			245	275	mV <sub>PP</sub>
Output ripple voltage			7	10	mV <sub>PP</sub>
Output rise time		4.7	8.4	15	ms
Operating frequency			700		kHz
Maximum efficiency	$V_I = 3.3\text{ V}, V_O = 2.5\text{ V}, I_O = 1.0\text{ A}$		93%		

**Note:** Maximum duty cycle is approached as  $V_I$  approaches 3 V, limiting input voltage range for  $V_O = 2.5\text{ V}$ .

Table 1–3. TPS54873EVM-225 Performance Specification Summary

Specification	Test Conditions	Min	Typ	Max	Units
Input voltage range		4.0	5.0	6.0	V
Output voltage set point		0.9	3.3	3.3	V
Output current range	$V_I = 4\text{ V to }6\text{ V}$			8	A
Line regulation	$I_O = 4\text{ A}$		$\pm 4$		mV
Load regulation	$V_I = 5\text{ V}, I_O = 0\text{ A to }8\text{ A}$		$\pm 5$		mV
Load transient response	$I_O = 2\text{ A to }6\text{ A}, t_r = 40\ \mu\text{s}$		-18		mV <sub>PK</sub>
			100		$\mu\text{s}$
	$I_O = 6\text{ A to }2\text{ A}, t_f = 40\ \mu\text{s}$		18		mV <sub>PK</sub>
			80		$\mu\text{s}$
Loop bandwidth	$V_I = 4\text{ V}$		100		kHz
Phase margin	$V_I = 4\text{ V}$		45		°
Loop bandwidth	$V_I = 6\text{ V}$		125		kHz
Phase margin	$V_I = 6\text{ V}$		45		°
Input ripple voltage			360	400	mV <sub>PP</sub>
Output ripple voltage			7	10	mV <sub>PP</sub>
Output rise time		4.7	8.4	15	ms
Operating frequency			700		kHz
Maximum efficiency	$V_I = 5\text{ V}, V_O = 3.3\text{ V}, I_O = 2.0\text{ A}$		93.5%		

### 1.3 Modifications

The TPS54x73EVM-225 is designed to demonstrate the small size that can be attained when designing with the TPS54x73, so many of the features which allow for extensive modifications have been omitted from this EVM. Changing the value of R4 can change the output voltage in the range of 0.9 V to 3.3 V. The value of R4 for a specific output voltage can be calculated by using equation 1. Table 1–4 lists the values for R4 for some common output voltages.

$$R4 = 10 \text{ k}\Omega \times \frac{0.891 \text{ V}}{V_O - 0.891 \text{ V}} \tag{1}$$

Table 1–4. Output Voltage Programming

Output Voltage (V)	R4 Value (k )
0.9	1000
1.2	28.7
1.5	14.7
1.8	9.76
2.5	5.49
3.3	3.74

The minimum output voltage is limited by the minimum controllable on-time of the device, 200 ns, and is dependent upon the duty cycle and operating frequency. The approximate minimum output voltage can be calculated using:

$$V_{OUTMIN} = 200 \text{ ns} \times f_s \times V_{INMIN} \tag{2}$$

The switching frequency may be trimmed to any value between 280 kHz and 700 kHz by changing the value of R6. Decreasing the switching frequency results in increased output ripple, unless the value of L1 is increased. A plot of the value of RT versus the switching frequency is given in Figure 1–1.

Figure 1–1. Frequency Trimming Resistor Selection Graph

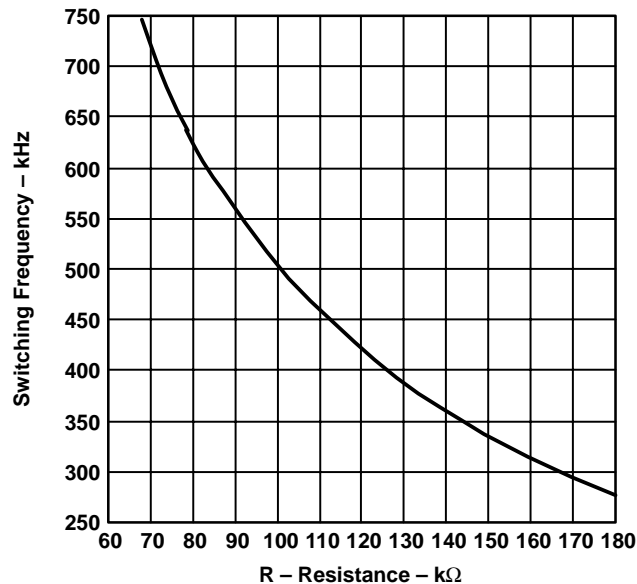

The TPS54x73EVM-225 EVM also supports alternate output filter configurations by means of pads located on the back side of the PCB. The positions for C15, C16, and C17 provide space for up to three electrolytic type surface mount capacitors, while the position for L2 accommodates popular inductors such as Vishay IHLP-5050 series with a 0.5 in. × 0.5 in. package. Since changes in the output filter affect the overall loop response, the user may find it desirable to change the values used in the compensation network (R1, R2, R3, C1, C2, and C3). The 0-Ω resistor R8 in the feedback path is provided as a convenient place to break the loop for testing any compensation value changes. While the provided compensation network can provide a stable output for a wide variety of output filter component values, it is always a good idea to verify any changes to the output filter or compensation network.

The primary intended usage for the TPS54x73 device family is in applications requiring a precharge condition on the output. These types of applications include power supplies for DSPs and microprocessors where the I/O and core voltages must track each other within a certain amount during start-up. The TPS54673 and TPS 54873 incorporate disable sink during start-up (DSDS) to allow this type of functionality in the SWIFT™ family of dc/dc converters. A typical design approach is to tie the output of the core voltage to the output of the I/O voltage with a number of series diodes so that the core voltage are at a level equal to the I/O voltage minus the drop across the diodes during start-up. The TPS54x73EVM-225 EVM provides four series diodes, D1 through D4, and allows the user to precharge the output from either the EVM input voltage or an external source. To use the input voltage as the precharge source, install a jumper across the J3 header. To supply an external source, use the J4 connector terminals, while leaving J3 open. Headers J5 through J8 are provided to select the number of series diodes; install a jumper across the header to bypass the adjacent diode. Care must be taken to use the correct number of diodes for the application. Under no circumstances can the output voltage be allowed to precharge to a level higher than the preset output voltage. If this condition occurs during start-up, the TPS54x73 device does not begin switching. If a voltage transient on the precharge voltage source causes the series diodes to conduct, current may be sunk through the low side FET in the device, possibly damaging the device. The actual voltage drop across the diodes during start-up depends on the initial load condition of the circuit as well as the ambient temperature.





# Test Setup and Results

---

---

---

---

This chapter describes how to properly connect, set up, and use the TPS54x73EVM-225 evaluation module. The chapter also includes test results typical for the TPS54x73EVM-225 and covers efficiency, output voltage regulation, load transients, loop response, output ripple, input ripple, and start-up.

<b>Topic</b>	<b>Page</b>
<b>2.1 Input/Output Connections</b> .....	<b>2-2</b>
<b>2.2 Efficiency</b> .....	<b>2-3</b>
<b>2.3 Power Dissipation</b> .....	<b>2-5</b>
<b>2.4 Output Voltage Regulation</b> .....	<b>2-6</b>
<b>2.5 Load Transients</b> .....	<b>2-8</b>
<b>2.6 Loop Characteristics</b> .....	<b>2-9</b>
<b>2.7 Output Voltage Ripple</b> .....	<b>2-11</b>
<b>2.8 Input Voltage Ripple</b> .....	<b>2-12</b>
<b>2.9 Start-Up</b> .....	<b>2-13</b>

## 2.1 Input/Output Connections

The TPS54x73EVM-225 has the following input/output connections: Vout J1, Vin J2, and Prechg\_in J4. A diagram showing the connection points is shown in Figure 2–1. A power supply capable of supplying 6 A should be connected to J2 through a pair of 20-AWG wires. The load should be connected to J2 through a pair of 16-AWG wires. The maximum load current may be reduced from 8 A for the TPS54873EVM–225 and 6 A for the TPS54673EVM–225. Wire lengths should be minimized to reduce losses in the wires. Test point TP1 provides a place to easily connect an oscilloscope voltage probe to monitor the output voltage. The TPS54X72 is intended to be used as a point of load regulator. In typical applications, it is usually located close to the input voltage source. When using the TPS54x73EVM-225 with an external power supply as the source for  $V_I$ , an additional bulk capacitor may be required, depending upon the output impedance of the source and length of the hookup wires. The test results presented are obtained using a 470  $\mu\text{F}$ , 16-V additional input capacitor. Connection is shown for no precharge only. To utilize the precharge feature, connect the optional power supply to the J4 connector or connect the input voltage to the series diode array by inserting a jumper across the J3 header.

Figure 2–1. Connection Diagram

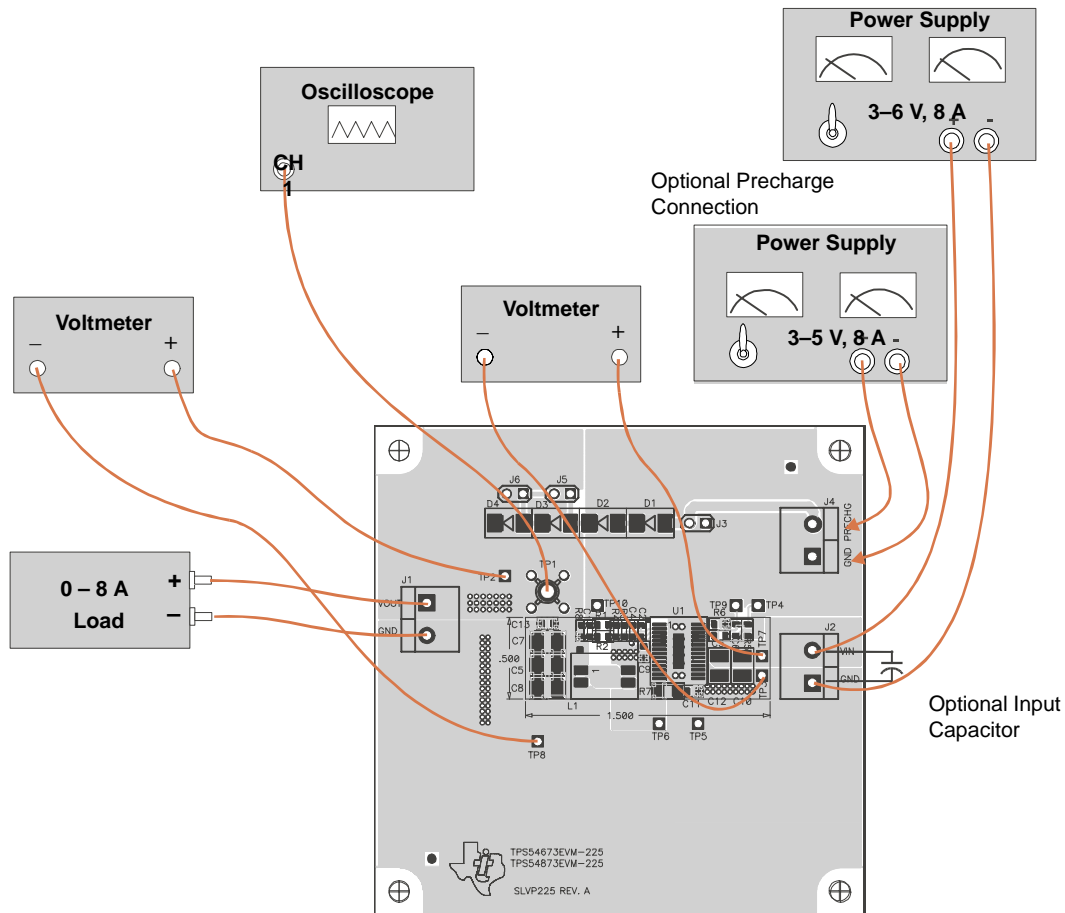

## 2.2 Efficiency

The TPS54x73EVM-225 efficiency peaks at load current of about 1 A to 2 A, and then decreases as the load current increases towards full load. The efficiency shown in *Figure 2–2* is for the TPS54673 and the TPS54873 at an ambient temperature of 25°C. The efficiency is lower at higher ambient temperatures, due to temperature variation in the drain-to-source resistance of the MOSFETs. The efficiency is slightly lower at 700 kHz than at lower switching frequencies, due to the gate and switching losses in the MOSFETs.

*Figure 2–2. Measured Efficiency, TPS54673*

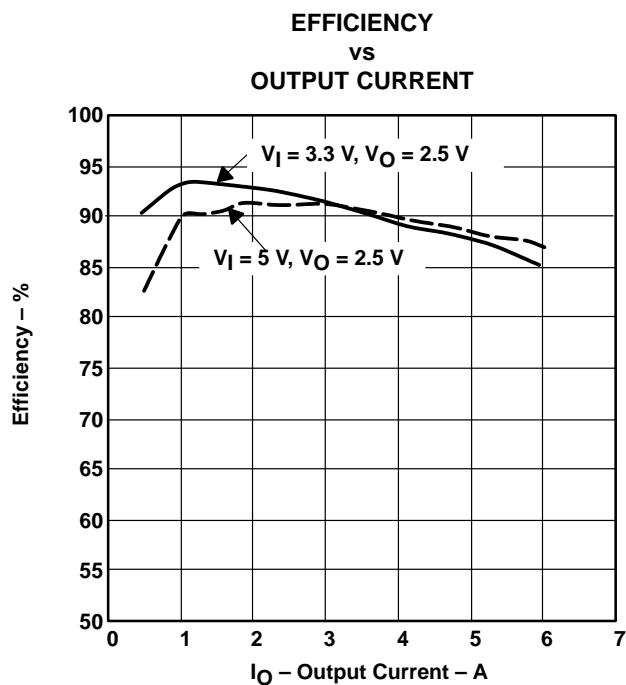
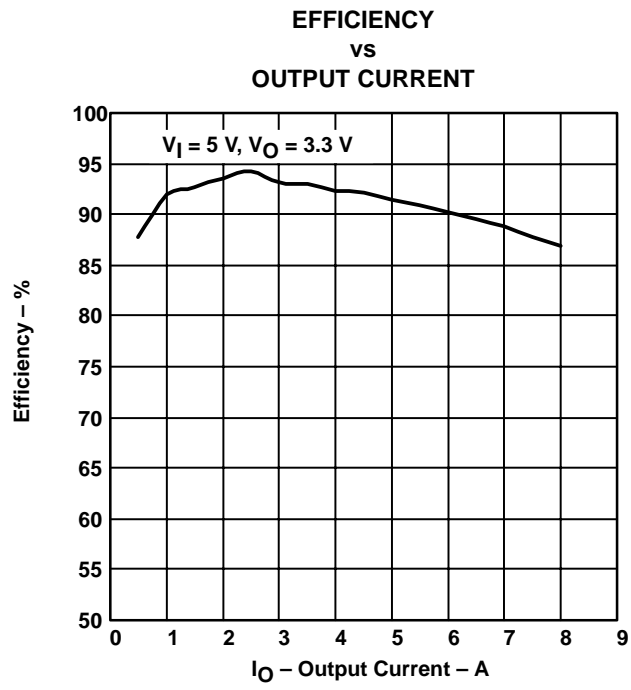

Figure 2–3. Measured Efficiency, TPS54873



## 2.3 Power Dissipation

The low junction-to-case thermal resistance of the PWP package, along with a good board layout, allows the TPS54x73EVM-225 EVMs to output full rated load current while maintaining safe junction temperatures. With a 3.3-V input source and a 6-A load, the junction temperature is approximately 60°C, while the case temperature is approximately 55°C. The total circuit losses at 25°C are shown in *Figure 2–4*. The input voltage for the TPS54673 is 3.3 V and for the TPS54673, 5.0 V. For additional information on the dissipation ratings of the devices, see the individual product data sheets.

*Figure 2–4. Measured Circuit Losses*

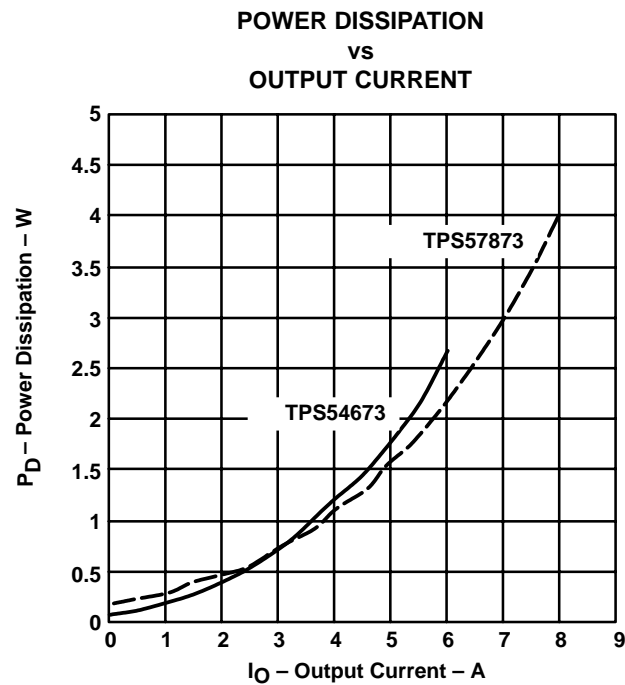

## 2.4 Output Voltage Regulation

The output voltage load regulation of the TPS54x73EVM-225 is shown in *Figure 2–5*, while the output voltage line regulation is shown in *Figure 2–6*. Measurements are given for an ambient temperature of 25°C.

*Figure 2–5. Load Regulation*

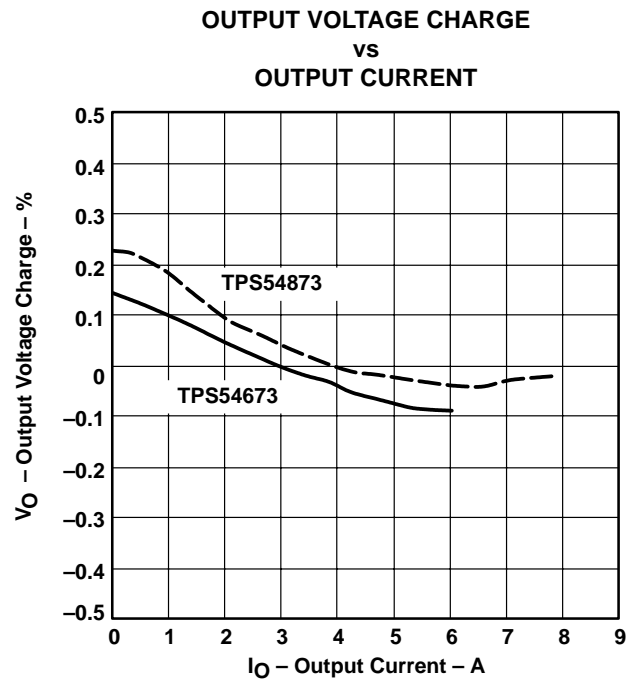
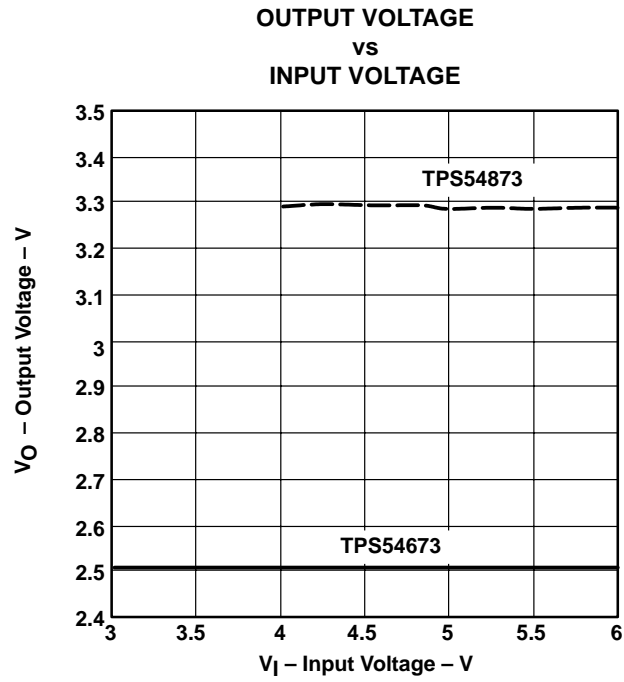

Figure 2–6. Line Regulation



**Note:** The lower limit for the TPS54673 input voltage is about 3.02 V because the device is operating at its maximum duty cycle.

## 2.5 Load Transients

The TPS54x73EVM–225 response to load transients is shown in *Figure 2–7* and *Figure 2–8*. The current step is from 25 to 75 percent of maximum rated load. Total peak-to-peak voltage variation is as shown, including ripple and noise on the output.

*Figure 2–7. Load Transient Response, TPS54673*

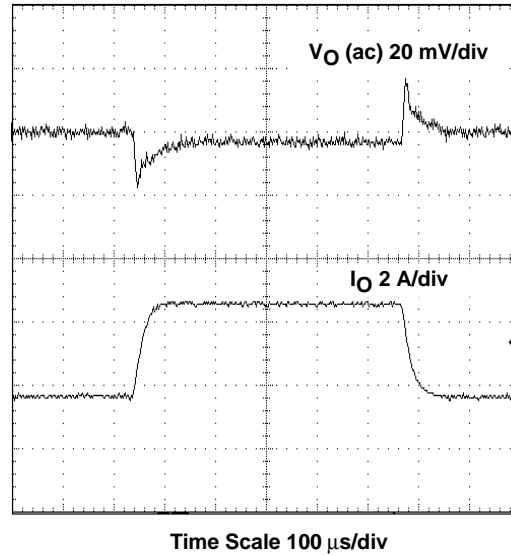

*Figure 2–8. Load Transient Response, TPS54873*

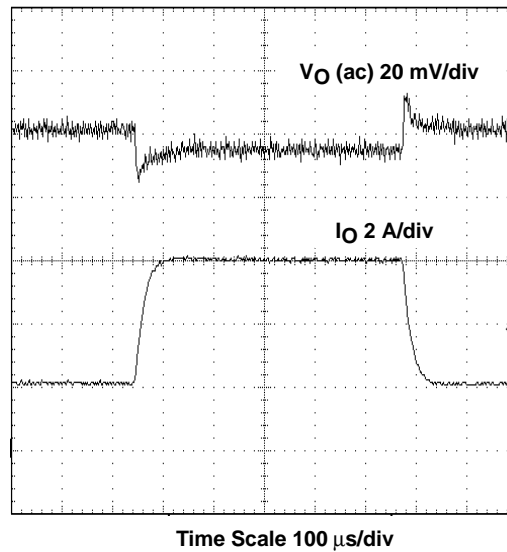



## 2.6 Loop Characteristics

The TPS54x73EVM-225 load response characteristics are shown in *Figure 2–9*, *Figure 2–10*, and *Figure 2–11*. The current step is from –50% to 50% of maximum rated load. Total peak-to-peak voltage variation is as shown, including ripple and noise on the output.

*Figure 2–9. Measured Loop Response, TPS54673,  $V_I = 3\text{ V}$*

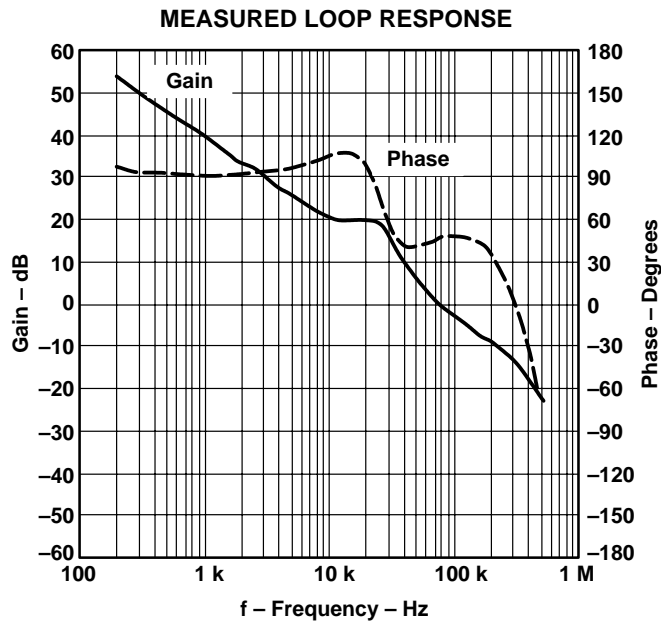

*Figure 2–10. Measured Loop Response, TPS54673,  $V_I = 6\text{ V}$*

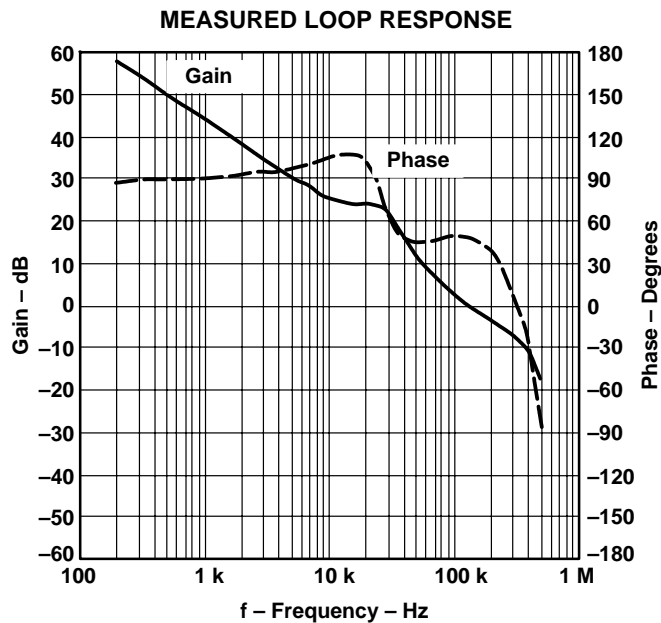

Figure 2–11. Measured Loop Response, TPS54873,  $V_I = 4\text{ V}$

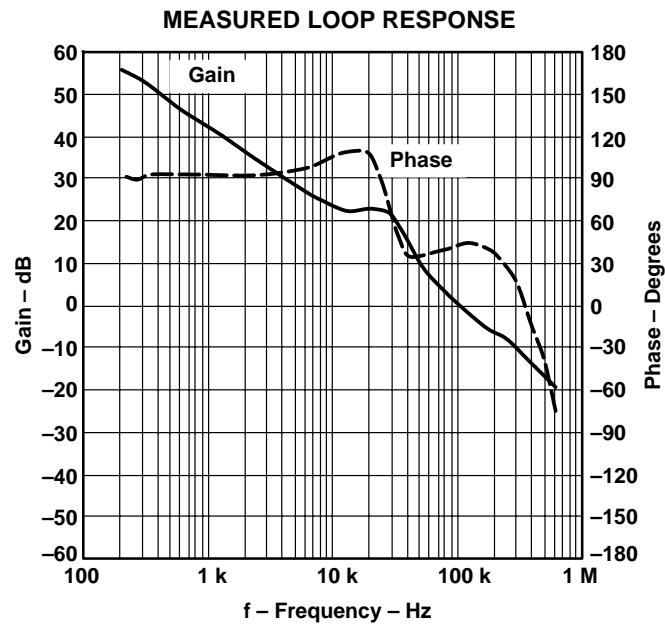
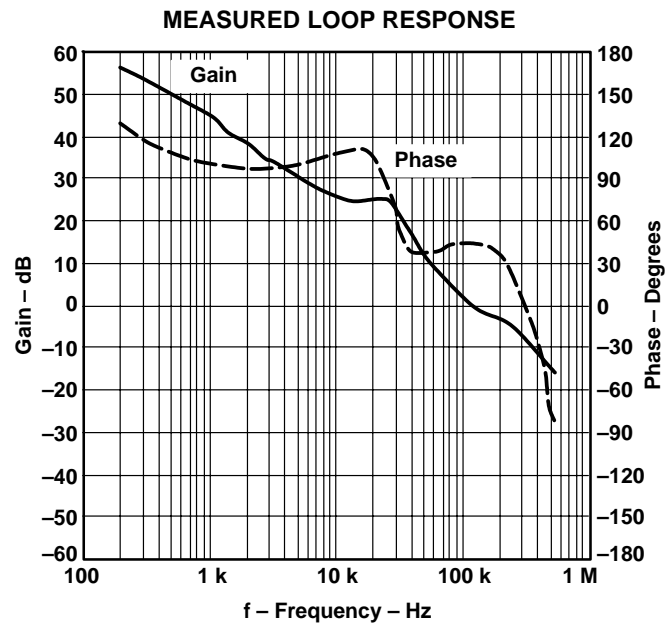

Figure 2–12. Measured Loop Response, TPS54873,  $V_I = 6\text{ V}$



## 2.7 Output Voltage Ripple

The TPS54x73EVM-225 output voltage ripple is shown in *Figure 2–13* and *Figure 2–14* for each device type. The input voltage is 3.3 V for the TPS54673. The input voltage is 5 V for the TPS54873. Output current for each device is the rated full load. Voltage is measured directly across output capacitors.

*Figure 2–13. Measured Output Voltage Ripple, TPS54673*

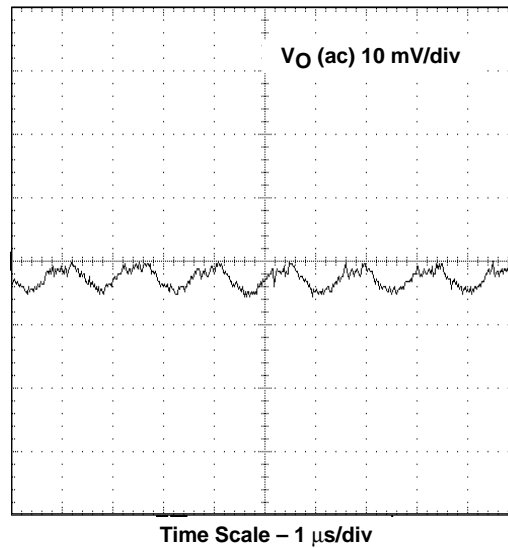

*Figure 2–14. Measured Output Ripple Voltage, TPS54873*

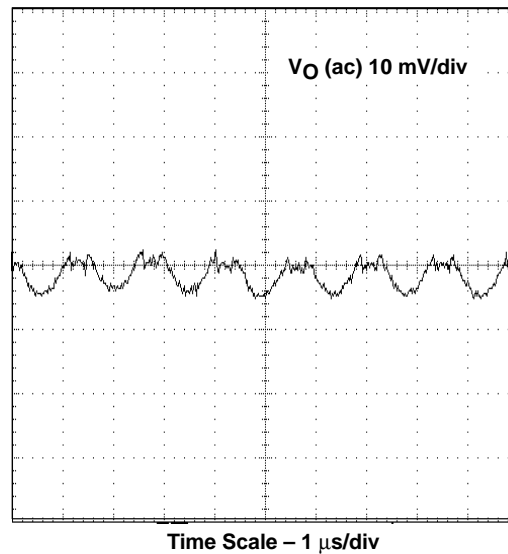

## 2.8 Input Voltage Ripple

The TPS54x73EVM-225 input voltage ripple is shown in *Figure 2–15* and *Figure 2–16* for each device type. The input voltage is 3.3 V for the TPS54673 the input voltage is 5 V for the TPS54873. Output current for each device is the rated full load.

*Figure 2–15. Input Voltage Ripple, TPS54673*

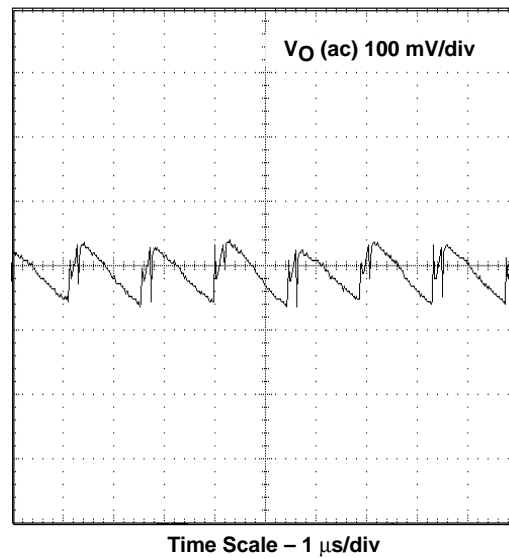

*Figure 2–16. Input Voltage Ripple, TPS54873*

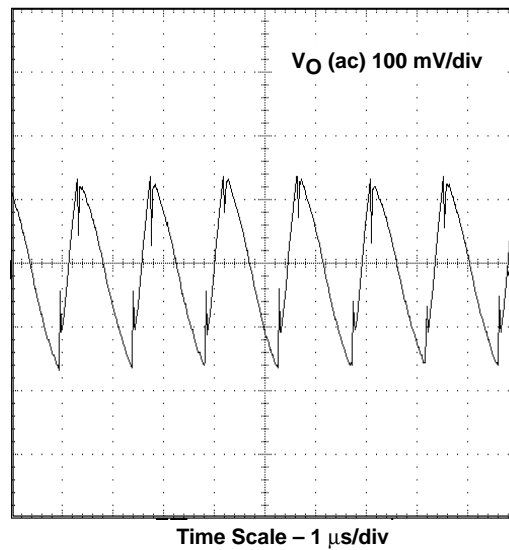

## 2.9 Start-Up

Start-up voltage waveforms of the TPS54673EVM–225 are shown in *Figure 2–17* through *Figure 2–19*. *Figure 2–17* shows the start-up waveform with no precharge on the output. When the  $V_I$  reaches the nominal 2.95-V UVLO threshold, the slow-start capacitor (C6) begins to charge. When the voltage on the SS/ENA pin reaches the enable threshold of 1.2 V, the internal reference begins to ramp up at the slow-start rate. As the internal reference voltage increases relative to the voltage at VSENSE, the duty cycle of the PWM comparator output increases. The internal FETs are inhibited from switching until the output of the PWM comparator reaches maximum duty cycle. When maximum duty cycle is reached, switching starts and the output rises quickly while the output voltage catches up with the slow-start ramp rate. At this point the voltage on the VSENSE pin matches the internal reference and the output continues to ramp up to the final set point value of 2.5 V at the slow-start rate.

*Figure 2–17. Measured Start-Up Waveform, TPS54673 With No Precharge*

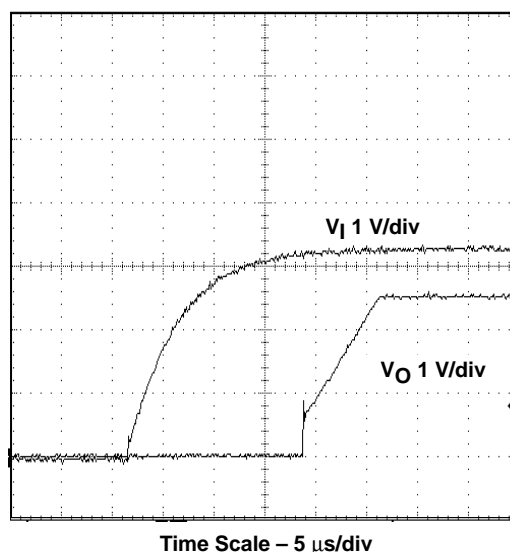

*Figure 2–18* Shows the start-up waveform with the output precharged and a 2- $\Omega$  load. The precharge is achieved by connecting the 3.3-V input to the output with two diodes in series. The start-up mechanism is the same as described above except that the internal reference must ramp up above the voltage fed back from the precharged output to the VSENSE pin before switching can start. Once this occurs, the output continues to ramp up to the output set point of 2.5 V at the slow-start rate.

Figure 2–18. Measured Start-Up Waveform, TPS54373 With Precharge

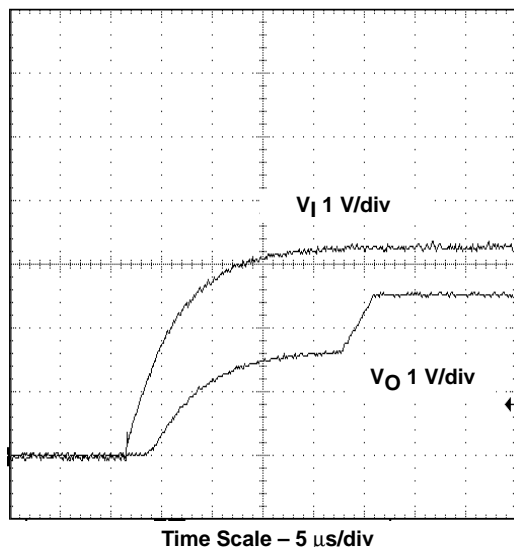

Figure 2–20 shows the start-up waveform with the output precharged and no load. Compare the precharge level to that in Figure 2–18 to see how start-up load current affects the voltage drop across the diodes and the final precharge voltage. As in the previous example, when the internal reference exceeds the voltage fed back to the VSENSE pin, the output begins to ramp up to its final preset value at the slow-start rate. It is important to note how the precharge level in Figure 2–19 is very close to the final output value. The precharge level must never exceed the output set point under any line or load condition for proper circuit operation.

Figure 2–19. Measured Start-Up Waveform, TPS54673 With Precharge and No Load

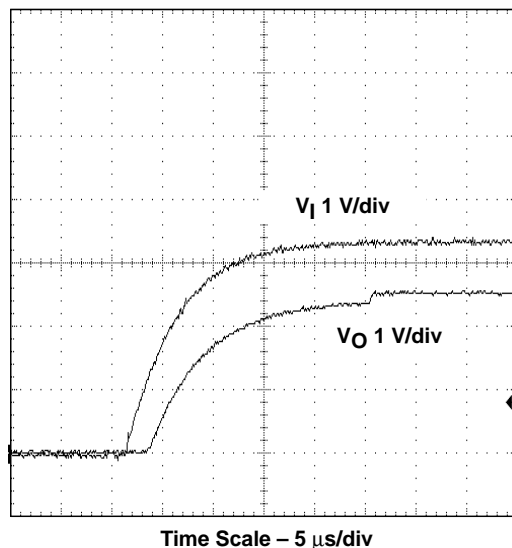

Figure 2–20, Figure 2–21, and Figure 2–22 show the same series start-up waveforms for the TPS54873-225. The above descriptions of the TPS54673 waveforms are applicable for the TPS54873 except that the input voltage is 5 V, the output voltage is 3.3 V, and the UVLO start-up threshold is 3.8 V.

Figure 2–20. Measured Start-Up Waveform

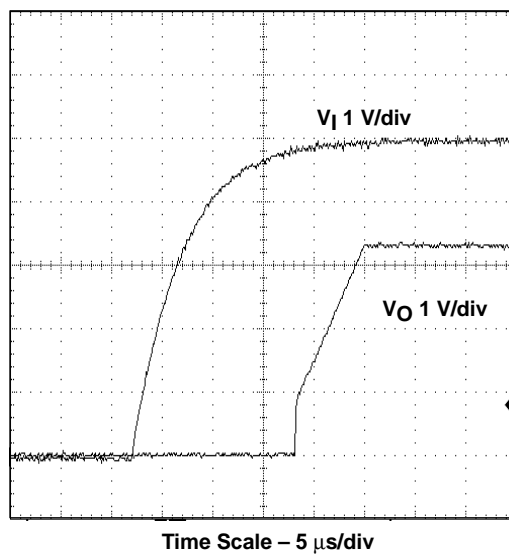

Figure 2–21. Measured Start-Up Waveform, TPS54873 With Precharge

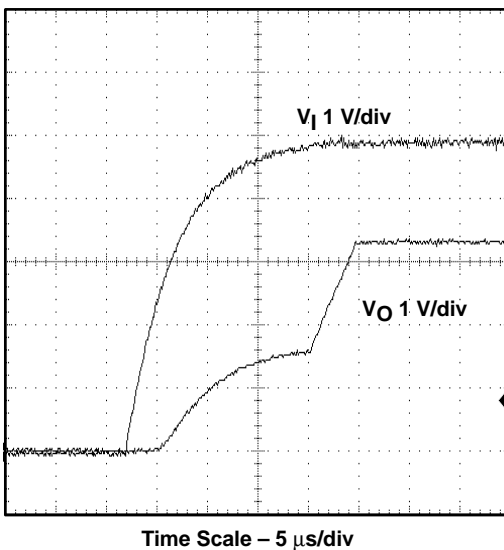
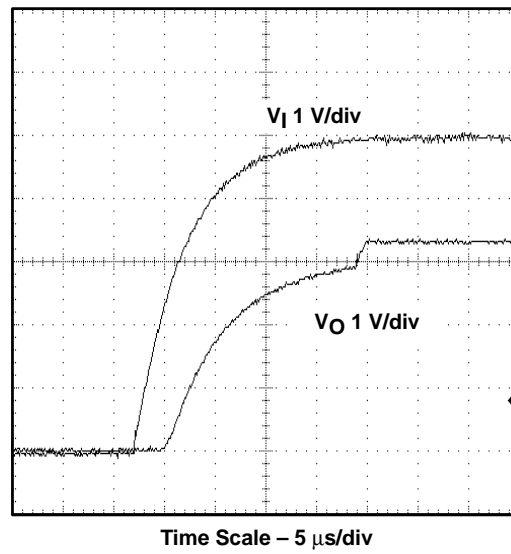

Figure 2–22. Measured Start-Up Waveform, TPS54873 With Precharge and No Load





# Board Layout

---

---

---

---

This chapter provides a description of the TPS54x73EVM-225 board layout and layer illustrations.

<b>Topic</b>	<b>Page</b>
3.1 Layout .....	3-2

### 3.1 Layout

The board layout for the TPS54x73EVM-225 is shown in Figure 3–1 through Figure 3–6. The top-side layer of the TPS54x73EVM-225 is laid out in a manner typical of a user application. The bottom layer of the TPS54x73EVM-225 is designed to accommodate an optional alternate output filter configuration. The top and bottom layers are 1.5 oz. copper, while the two internal layers are 0.5 oz. copper.

The top layer contains the main power traces for  $V_I$ ,  $V_O$ , and  $V_{(phase)}$ . Also on the top layer are connections for the remaining pins of the TPS54x73 and a large area filled with ground. The two internal layers are identical and are dedicated ground planes. The bottom layer contains pads for an optional alternate output filter, including space for three D3 or D4 case size electrolytic capacitors and an alternate inductor of 0.5 in. x 0.5 in. size ground traces. The top and bottom ground traces are connected to the internal ground planes with multiple vias placed around the board including 12 directly under the TPS54x73 device to provide a thermal path from the PowerPAD™ land to ground.

The input-decoupling capacitors (C10 and C12), bias-decoupling capacitor (C3), and boot-strap capacitor (C9) are all located as close to the IC as possible. In addition, the compensation components are also kept close to the IC. The compensation circuit ties to the output voltage at the point of regulation, adjacent to the high frequency bypass output capacitor.

Figure 3–1. Top-Side Layout

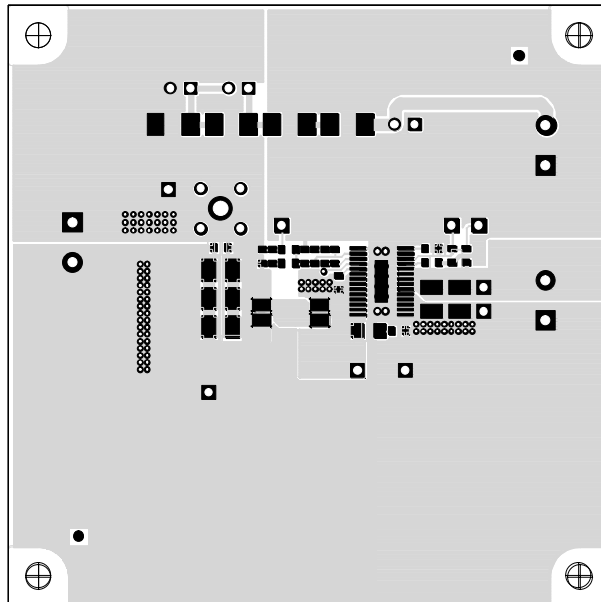

Figure 3–2. Internal Layer 1 Layout

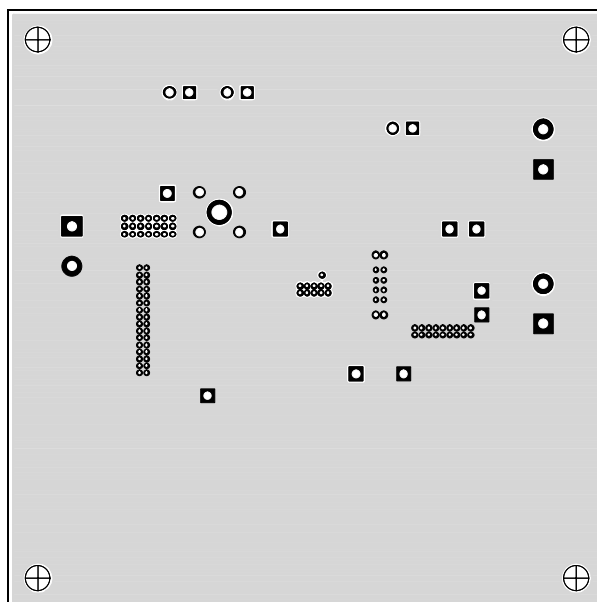

Figure 3–3. Internal Layer 2 Layout

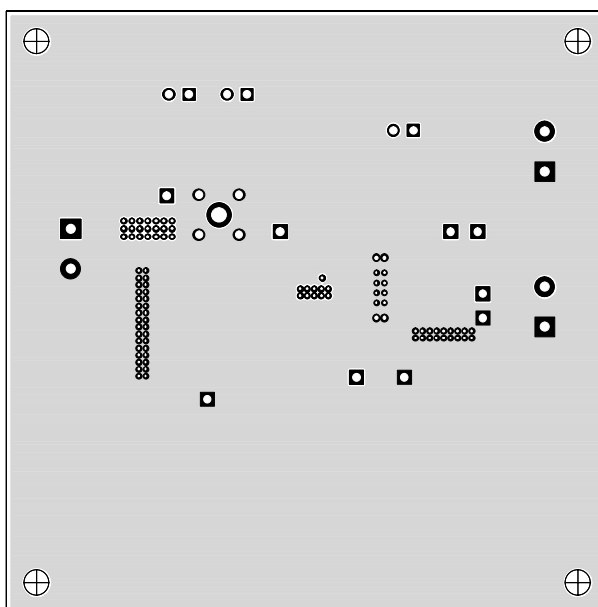

Figure 3–4. Bottom Side Layout (Looking From Top Side)

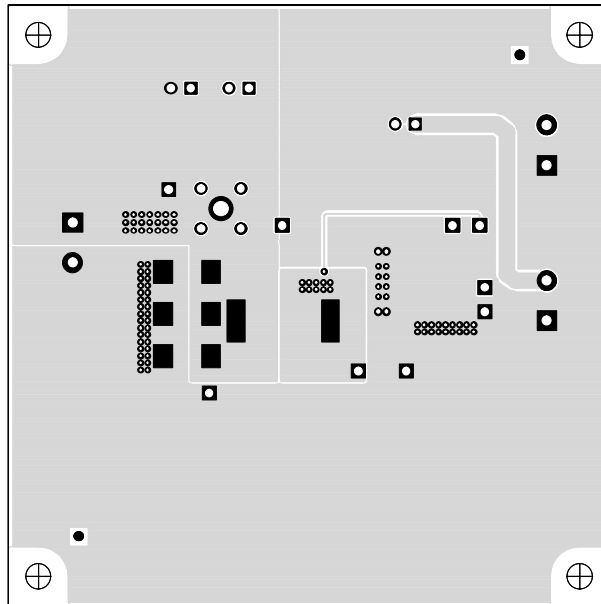

Figure 3–5. Top Side Assembly

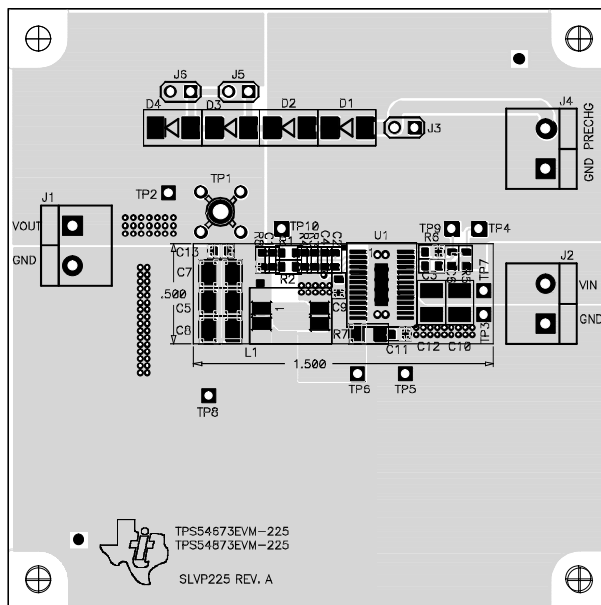
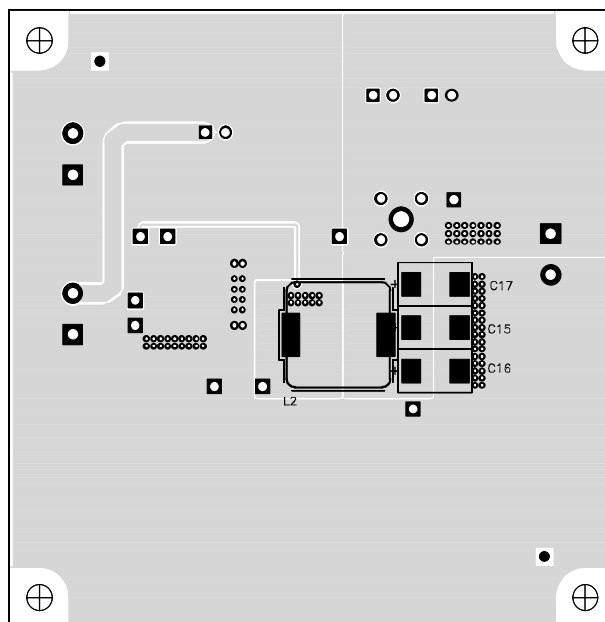

Figure 3–6. Bottom Side Assembly (Showing Optional Components)





# Schematic and Bill of Materials

---

---

---

The TPS54x73EVM-225 schematic and bill of materials are presented in this chapter.

<b>Topic</b>	<b>Page</b>
4.1 Schematic .....	4-2
4.2 Bill of Materials .....	4-3

### 4.1 Schematic

Figure 4–1. TPS54x73EVM-225 Schematic

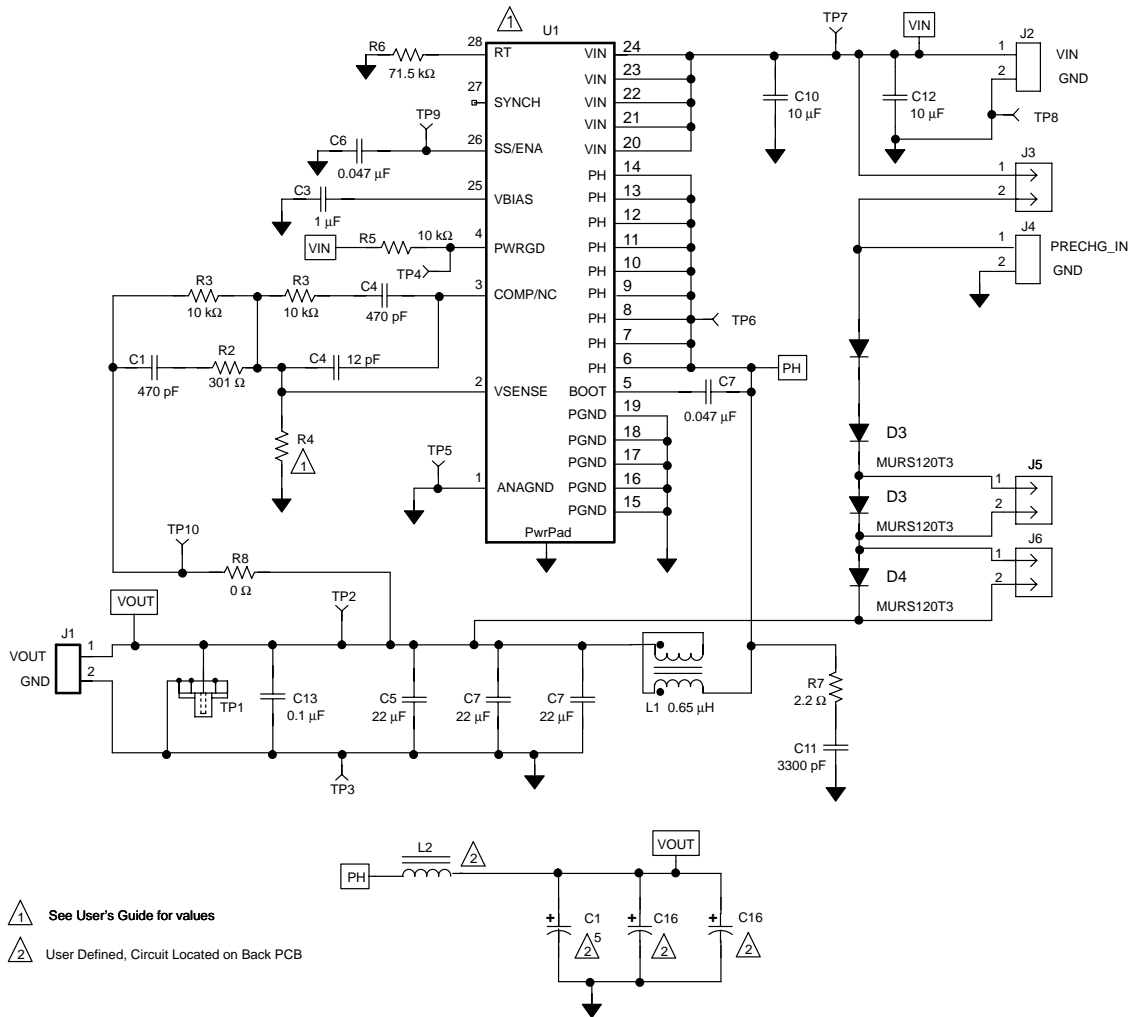



## 4.2 Bill of Materials

Table 4–1. TPS54x73EVM-225 Bill of Materials

Count		RefDes	Description	Size	MFR	Part Number
–1	–2					
2	2	C1, C4	Capacitor, ceramic, 470 pF, 50 V, C0G, 5%	603	Panasonic	GRM1885C1H471JA01
2	2	C10, C12	Capacitor, ceramic, 10 $\mu$ F, 10 V, X5R, 20%	1210	Taiyo Yuden	LMK325BJ106MN
1	1	C11	Capacitor, ceramic, 3300 pF, 50 V, X7R 10 %	603	Panasonic	ECJ–1VB1H332K
1	1	C13	Capacitor, ceramic, 0.1 $\mu$ F, 25 V, X7R, 10%	603	Murata	GMR188R71E104KA01
–	–	C15, C16, C17	Open	7343 (D)		
1	1	C2	Capacitor, ceramic, 12 pF, 50 V, C0G, 5%	603	Murata	GRM1885C1H120JZ01
1	1	C3	Capacitor, ceramic, 1 $\mu$ F, 10 V, X5R, 10%	603	TDK	C1608X5R1A105M
3	3	C5, C7, C8	Capacitor, ceramic, 22 $\mu$ F, 6.3 V, X5R, 20%	1210	Taiyo Yuden	JMK325BJ226MN
2	2	C6, C9	Capacitor, ceramic, 0.047 $\mu$ F, 25 V, X7R, 10%	603	Murata	GRM188R71E473KA01
4	4	D1, D2, D3, D4	Diode, ultra fast rectifier, 1 A, 200 V	SMB	On Semiconductor	MURS120T3
3	3	J1, J2, J4	Terminal block, 2 pin, 15 A, 5,1 mm	148830	OST	ED1609
3	3	J3, J5, J6	Header, 2 pin, 100 mil spacing, (36-pin strip)	0.100x2	Sullins	PTC36SAAN
1	1	L1	Inductor, 0.65 $\mu$ H, 12 A	0.340x0.250	Pulse	PA0277
–	–	L2	Open	0.51 x 0.51		
4	4	R1, R2, R6, R7	Resistor, chip, 10.0 k $\Omega$ , 1/16–W, 1%	603	Std	Std
3	3	R1, R3, R5	Resistor, chip, 10 k $\Omega$ , 1/16 W, 1%	603	Std	Std
1	1	R2	Resistor, chip, 301 $\Omega$ , 1/16 W, 1%	603	Std	Std
1		R4	Resistor, chip, 5.49 k $\Omega$ , 1/16 W, 1%	603	Std	Std
	1	R4	Resistor, chip, 3.74 k $\Omega$ , 1/16 W, 1%	603	Std	Std
1	1	R6	Resistor, chip, 71.5 k $\Omega$ , 1/16 W, 1%	603	Std	Std
1	1	R7	Resistor, chip, 2.2 $\Omega$ , 1/16 W, 1%	603	Std	ERJ-8RQF2R2
1	1	R8	Resistor, chip, 0 $\Omega$ , 1/15 W, 1%	603	Std	Std
1	1	TP1	Adapter, 3,5 mm probe clip (or 131-5031-00)	72900	Tektronic	131-4244-00
6	6	TP2, TP4, TP6, TP7, TP9, TP10	Test point, red, 1 mm	0.038"	Farnell	240–345
3	3	TP3, TP5, TP8	Test point, black, 1 mm	0.038"	Farnell	240-333
1	–	U1	IC, SWIFT dc/dc converter, 3 V to 6 V, 6 A	PWP28	TI	TPS54673PWP
–	1	U1	IC, SWIFT dc/dc converter, 3 V to 6 V, 6 A	PWP28	TI	TPS54873PWP

Table 4–1. TPS54x73EVM-225 Bill of Materials (Continued)

Count		RefDes	Description	Size	MFR	Part Number
-1	-2					
1	1	–	PCB, 3 in. × 3 in. × 0.062 in.		Any	SLVP225
3	3	–	Shunt, 100 mil, black	0.100	3M	929950-00